

RA-b ACQUA - RUBINETTERIE da BANCO

Bench water taps

Certificati / Certificates: EN 13792:2000 / DIN 12898 / DIN 12918 / ISO 228-1

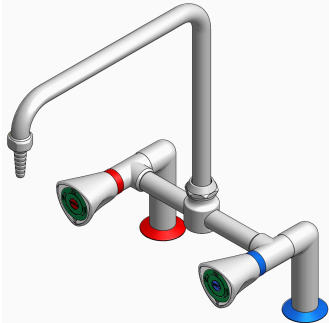

MA90206
Miscelatore 2 ingressi
Water mixer

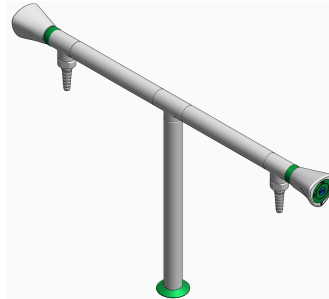

MA90210
Colonna acqua fredda 2 vie "T"
Bench cold water column, "T" shape

MA90213
Colonna acqua demi 2 vie "T"
Demineralized water column, "T" shape



MA90211
Colonna acqua fredda 1 via "L"
Bench cold water column, "L" shape

MA90212
Colonna acqua demi 1 via "L"
Demineralized water column, "L" shape

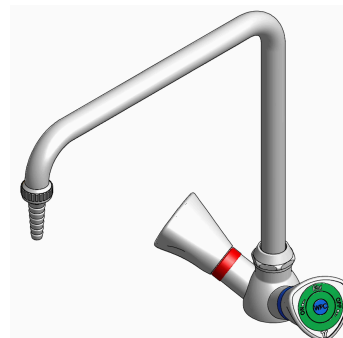

MA90402
Miscelatore monoforo
Water mixer

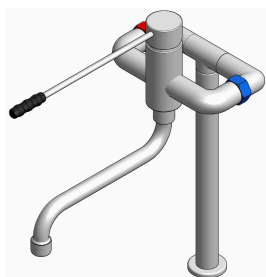

MA90404
Miscelatore monoforo comando a gomito
One hole mixer, clinical lever



MA90214
Colonna acqua fredda collo cigno girevole
Cold water column, turning swan-necked

RUBINETTI
Taps

MA90

MA95

RA-a ACQUA - RUBINETTI su ALZATA PANNELLATA

Water taps for wall panel

Certificati / Certificates: EN 13792:2000 / DIN 12898 / DIN 12918 / ISO 228-1

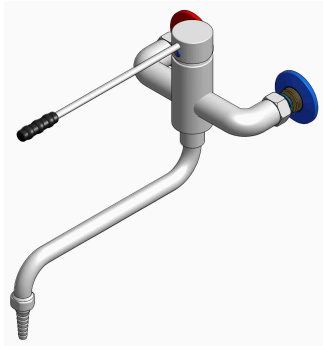

MA90100
Miscelatore a leva a gomito
Mixer, clinical lever

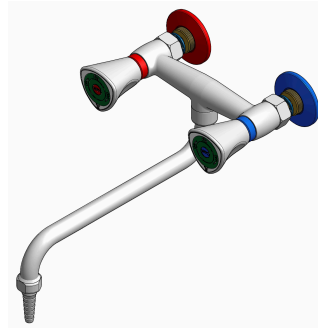

MA90103
Miscelatore 2 ingressi canna inferiore
Mixer, lower spout

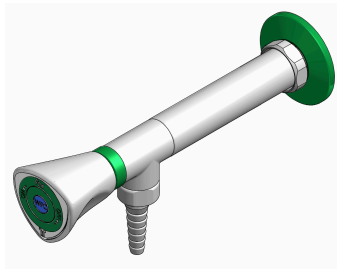

MA90104
Rubinetto acqua fredda 1 via
Cold water tap, 1 way

MA90104D
Rubinetto acqua demi 1 via
Demineralized water tap, 1 way

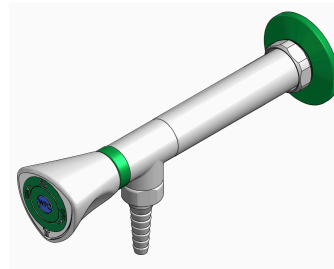

MA90105
Rubinetto acqua fredda 1 via, per vasche
Cold water tap, 1 way, for sink

MA90105D
Rubinetto acqua demi 1 via, per vasche
Demineralized water tap, 1 way, for sink



MA90108
Rubinetto acqua fredda 1 via, canna girevole
Cold water tap, 1 way, turning spout

RUBINETTI
Taps

MA90

MA95

RG-b GAS - RUBINETTERIE DA BANCO

Bench gas taps

Certificati / Certificates: EN 13792:2000 / DIN 12898 / DIN 12918 / ISO 228-1

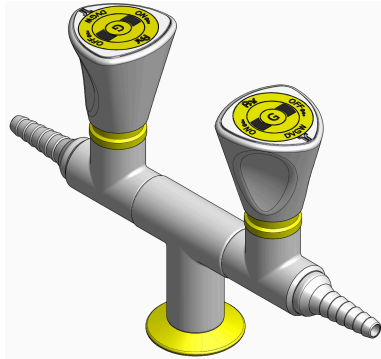

MA90500
Colonna gas 2 vie 180°
Gas tap, 2 way, 180°

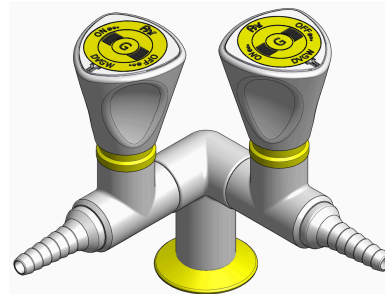

MA90501
Colonna gas 2 vie 90°
Gas tap, 2 ways, 90°

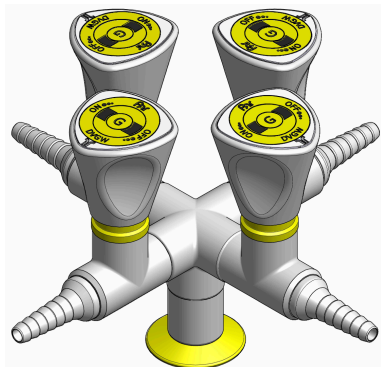

MA90502
Colonna gas 1 via
Gas tap, way

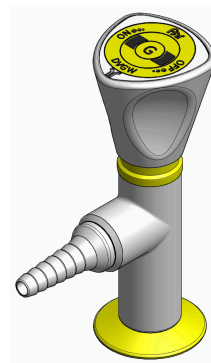

MA90503
Colonna gas 4 vie 180°
Gas tap, 4 ways 180°

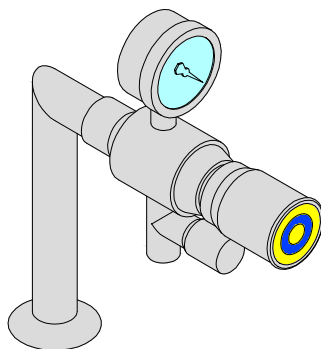

MA90RID/T
Colonna gas 1 via con manometro
Gas column, 1 way, with manometer

RUBINETTI
Taps

MA90

MA95

RG-a GAS - RUBINETTI SU ALZATA PANNELLATA

Parete
Wall

Gas taps for wall panel

Certificati / Certificates: EN 13792:2000 / DIN 12898 / DIN 12918 / ISO 228-1

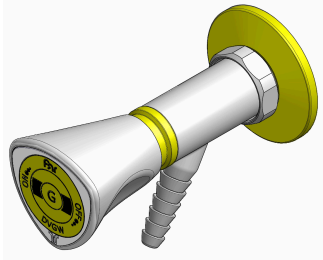

MA90505
Rubinetto gas 1 via
Gas tap, 1 way

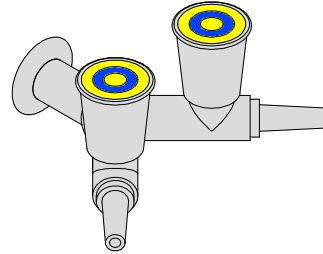

MA90506
Rubinetto gas 2 vie
Gas tap, 2 ways

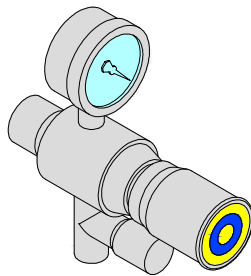

MA90RID
Rubinetto gas 1 via con manometro
Gas tap, 1 way, with manometer

RUBINETTI
Taps

MA90

MA95

RG-a GAS - RUBINETTI su UNITA' TECNICA

Gas taps for wall panel

Certificati / Certificates: EN 13792:2000 / DIN 12898 / DIN 12918 / ISO 228-1

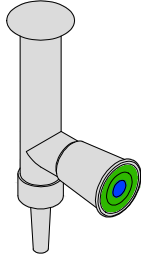

MA95505
Rubinetto verticale gas 1 via
Vertical gas tap, 1 way

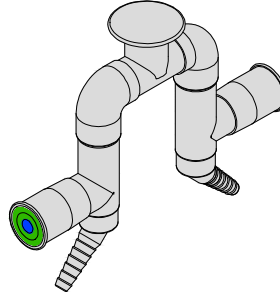

MA95506
Rubinetto verticale gas 2 vie
Vertical gas tap, 2 ways

RUBINETTI
Taps

MA95
AIR

RA-a ACQUA - RUBINETTI su UNITA' TECNICA

Water taps for technical unit

Certificati / Certificates: EN 13792:2000 / DIN 12898 / DIN 12918 / ISO 228-1

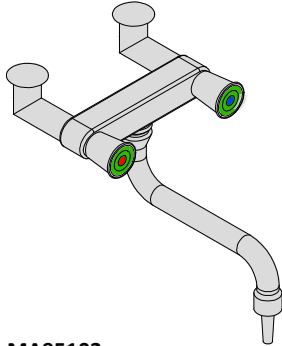

MA95103
Miscelatore 2 ingressi
Mixer, two inlets

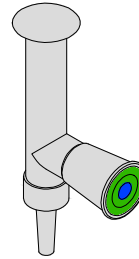

MA95104
Rubinetto verticale acqua 1 via
Vertical water tap, 1 way

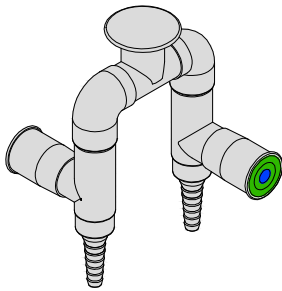

MA95107
Rubinetto verticale acqua 2 vie
Vertical water tap, 2 ways

RUBINETTI
Taps

MA95
AIR